

## GW1101 Series

### Modbus Gateway user manual

#### 【Summarize】

GW1101 series products are MODBUS gateway device. The series products include GW1101-1D (RS-232) and GW1101-1D (RS-485) two models, which are used as a connection between Modbus TCP and Modbus RTU/ASCII devices. The series products provided 1 port RS232 (RJ45 connector) or RS485/422 (5 bit terminal block) and 1 port 10/100M Ethernet.

Modbus TCP, Modbus RTU and Modbus ASCII protocol are integrated in the series of products, users can easily realize the seamless integration of Modbus Ethernet devices and Modbus serial devices and even multi master and slave hybrid networks. At the same time, the user can be set up by Web or Telnet. The simple design can not only realize the fast application, but also guarantee the application of the entire real environment.

The series of products using EMC protection design. Power has over current, over voltage protection, and can work in rugged environment. The design supports wall mounting installation, easy to use for your projects.

#### 【Packing list】

Please check the packaging and accessories by your first using.

- Modbus gateway × 1
- User manual × 1
- CD × 1
- Certificate of quality × 1
- Warranty card × 1
- Power adapter × 1

Please inform us or our distributor if your equipments have been damaged or lost any accessories, we will try our best to satisfy you.

#### 【Feature】

- Support 1 port RS232 (RJ45 connector) or 1 port RS485/422 (5 bit terminal block)

- Support 1 10/100M adaptive Ethernet interface
- 300bps~115200bps baud rate and nonblocking communication
- Support Modbus TCP, Modbus RTU, Modbus ASCII, IP, ARP, DHCP, DNS protocol
- Slave mode support 16 TCP master connections
- Master mode support 32 slave TCP connection requests
- Support RTU Slave, RTU Master, ASCII Slave, ASCII Master four operating modes
- Support Response Timeout and Interval Timeout setting
- Support ID mapping function, to achieve the management of the host ID
- Support Telnet and Web
- Support IP address and MAC address filtering function
- Support gateway, cross route communication
- IP30 grade protection, metal shell, wall mounted installation
- Working temperature is -40~75℃

#### 【Panel layout】

##### GW1101-1D (RS-232)-P(9~48VDC)

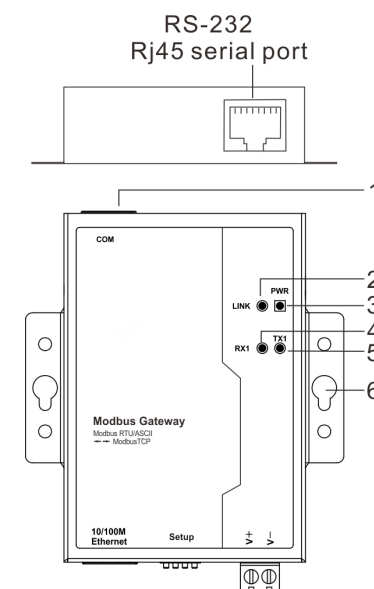

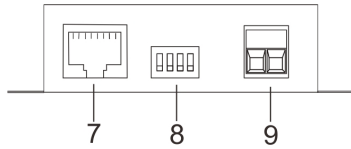

1. RS-232 Serial
2. Ethernet port LED indicator
3. Power LED indicator
4. Serial receive data indicator
5. Serial transmit data indicator
6. Wall mounting installation
7. 10Base-T /100Base-TX Ethernet port
8. DIP switch
9. Power input 9~48VDC

2. Ethernet port LED indicator
3. Power LED indicator
4. Serial receive data indicator
5. Serial transmit data indicator
6. Wall mounting installation
7. 10Base-T /100Base-TX Ethernet port
8. DIP switch
9. Power input 9~48VDC

**【Appearance and dimension】**

The shell size of the series is the same, but the type of the interface is different. Unit (mm)

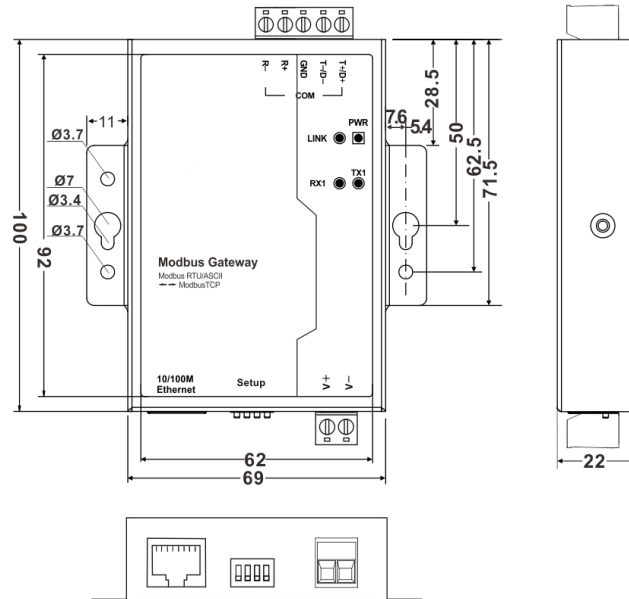
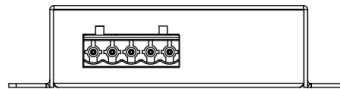

**【Power supply input】**

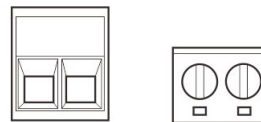

**GW1101-1D (RS-485)-P(9~48VDC)**

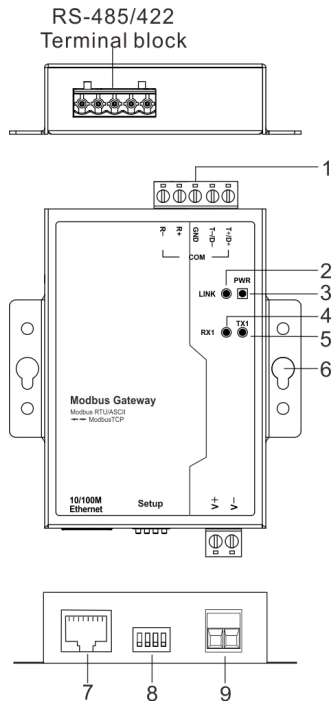

1. RS-485/422 Serial

GW1101 series provide DC power input, voltage input is the two terminal form, plug type 2 core spacing of 5.08mm terminals, wherein the power input range of 9 ~ 48VDC. (V+, V-)

**【DIP switch】**



Top panel provide 4 bit DIP switch to set function(ON is effective), 1, 3, 4 is hold, 2 is factory default, if you change the DIP switch statue, please power off and power on.

**【Communication connector】**

The series products support 1 Ethernet ports and 1 serial ports (RJ45 or 5 bit terminal interface).

**10/100BaseT(X) Ethernet port**

The pinout of RJ45 port display as below, connect by UTP or STP. The connect distance is no more than 100m. 100Mbps is used 120Ω of UTP 5; 10Mbps is used 120Ω of UTP 3, 4, 5.

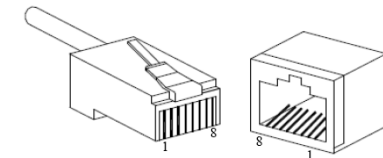

RJ 45 port support automatic MDI/MDI-X operation. Can connect the PC, Server, Converter and HUB .Pin 1,2,3,6 Corresponding connections in MDI. 1→3, 2→6, 3→1, 6→2 are used as cross wiring in the MDI-X port of Converter and HUB. 10Base-T/100Base-TX are used in MDI/MDI-X, the define of Pin in the table as below.

NO.	MDI signal	MDI-X signal
1	TX+	RX+
2	TX-	RX-
3	RX+	TX+
6	RX-	TX-
4, 5, 7, 8	—	—

Note: “TX±”Transmit Data±, “RX±”Receive Data±, “—”Not Use.

### MDI (straight-through cable)

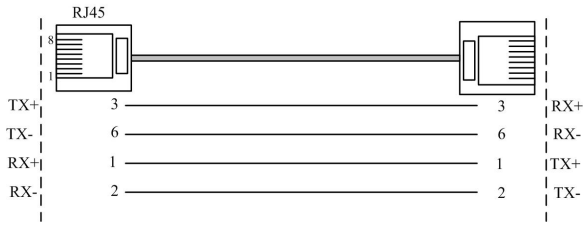

### MDI-X (Cross over cable)

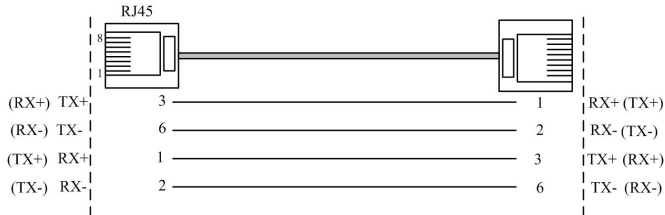

MDI/MDI-X auto connection makes switch easy to use for customers without considering the type of network cable.

### Serial port connection

RS-232 adopts RJ45 connector. The PIN define is as follows:

RS-232 port:

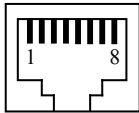

PIN	PIN define	Description
1	TXD	Transmit data
2	RXD	Receive data
3	CTS (Optional)	Clear to send
6	RTS (Optional)	Request to send
8	GND	Signal ground

RS-485/422 port:

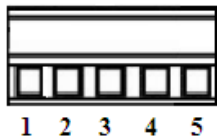

PIN	RS-485 PIN define	RS-422 PIN define
1	D+	T+
2	D-	T-
3	GND	GND
4	--	R+
5	--	R-

### 【LED Indicator】

LED indicator light on the front panel of product, the function of each LED is described in the table as below.

System status LED		
LED	Indicate	Description
PWR	ON	Power is connected/Function natural
	OFF	Power is disconnected or function nu-natural
LINK	ON	Ethernet port connect successfully
	Flashing	Ethernet port has data transmission
	OFF	Ethernet port connect unsuccessfully
RX1	OFF	None data receive
	Flashing	In receiving data
TX1	OFF	None data transmit
	Flashing	In transmitting data

### 【Installation】

Before installation, confirm that the work environment meet the installation require, including the power needs and abundant space. Whether it is close to the connection equipment and other equipments are prepared or not.

1. Avoid in the sunshine, keep away from the heat fountainhead or the area where in intense EMI.
2. Examine the cables and plugs that installation requirements.
3. Examine whether the cables be seemly or not (less than 100m) according to reasonable scheme.

4. Screws, nuts, tools need to be prepared in advance of your own.

5. Power: 9~48VDC power input

6. Environment: working temperature -40~75℃

Storage Temperature: -40~85℃

Relative humidity 5%~95%

### DIN-Rail mounting

Product support wall or rail mounted, DIN rail accessories can purchase in the purchase of the product.

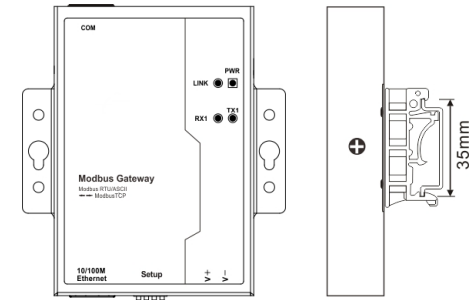

### Wiring Requirements

Cable laying need to meet the following requirements:

1. It is needed to check whether the type, quantity and specification of cable match the requirement before cable laying;
2. It is needed to check the cable is damaged or not, factory records and quality assurance booklet before cable laying;
3. The required cable specification, quantity, direction and laying position need to match construction requirements, and cable length depends on actual position;
4. All the cable cannot have break-down and terminal in the middle;
5. Cables should be straight in the hallways and turning;
6. Cable should be straight in the groove, and cannot beyond the groove in case of holding back the inlet and outlet holes. Cables should be banded and fixed when they are out of the groove;
7. User cable should be separated from the power lines.

Cables, power lines and grounding lines cannot be overlapped and mixed when they are in the same groove road. When cable is too long, it cannot hold down other cable, but structure in the middle of alignment rack;

8. Pigtail cannot be tied and swerved as less as possible. Swerving radius cannot be too small (small swerving causes terrible loss of link). Its banding should be moderate, not too tight, and should be separated from other cables;

9. It should have corresponding simple signal at both sides of the cable for maintaining.

## 【Specification】

### Ethernet port

Standard: 10Base-T, 100Base-TX

Protocol: Support Modbus TCP, Modbus RTU, Modbus ASCII, IP, APR, ICMP, DNS and DHCP

Signal: Rx+, Rx-, Tx+, Tx-

Speed: 10/100Mbps

Working: Full-duplex and half duplex

Transfer distance: 100m

Connector: RJ45

### Serial port

Serial port number: 1 ports RS-232 or 1 ports RS-485/422

RS-232 signal: RXD, TXD, GND, RTS, CTS

RS-485 signal: D+(A), GND, D-(B)

RS-422 signal: T+, T-, GND, R+, R-

Parity bit: None, Even, Odd, Space, Mark

Data bit: 7bit, 8bit

Stop bit: 1bit, 2bit

Baud rate: 300bps~115200bps

RS-232 Transfer distance: no more than 15m

RS-232 connector: RJ45

RS-485/422 transfer distance: 1200m

RS-485/422 connector: 5 bits terminal block

Protection: class 3 static

Work mode: RTU Slave, RTU Master, ASCII Slave, and ASCII Master

Multiple master and multi slave connection:

Master mode: maximum 32 TCP slave

Slave mode: 16 TCP master (each master allows 32 commands)

### LED Indicator

Power (PWR)

Ethernet port connect statue (Link)

Serial port data indicator: TX1, RX1

### Power requirements

Input voltage: 9~48VDC

Type of input: 2 bits terminal block

### Consumption

➤ GW1101-1D(RS-232)-P(9~48VDC)

No-load consumption: 0.54W@9V

Full-load consumption: 0.78W@9V

➤ GW1101-1D(RS-485)-P(9~48VDC)

No-load consumption: 0.90W@9V

Full-load consumption: 1.61W@9V

### Mechanical

Shell: IP30 protection, metal shell

Installation: Wall mounting

Weight: 230g

Size (L×W×H): 100mm×69mm×22mm

### Environment limits

Working temperature: -40~75℃

Storage temperature: -40~85℃

Relative humidity: 5%~95% (non-condensing)

### Standard

EMI: EN 55022 Class A, FCC Part 15 Subpart B Class A

EMS: EN 61000-4-2 (ESD), Level 3

Shock: IEC 60068-2-27

Free fall: IEC 60068-2-32

Vibration: IEC 60068-2-6

### Warranty

Warranty time: 3 years

### Certificates

CE, FCC, RoHS, UL508 (pending)